

INSTALLATION ADJUSTMENT SERVICE MEGATRON MODEL 8N, 8N-LF, 8NB-LF

Note: IMPORTANT! Provide serial numbers for both valves when ordering parts!!

INSTALLATION



WARNING: This product can expose you to chemicals including lead, which is known to the State of California to cause cancer. For more information, go to www.P65Warnings.Ca.gov

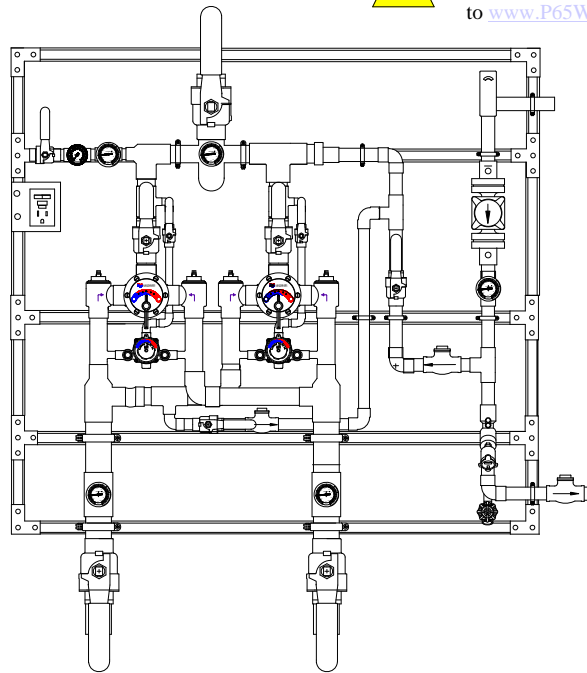

1. Type TM Parallel Systems are factory pre-assembled and tested and include large and small thermostatic water mixing valves which function as a system to meet both high and low demand for tempered water.
2. System should be installed at a location where it can easily be cleaned, adjusted or repaired.
3. System supplies must be connected as shown (Hot-left, Cold-right). Exercise caution when soldering.

4. Flush pipes thoroughly after system has been connected.
5. Assemblies installed on a recirculated hot water system **MUST** be piped according to **LEONARD'S REQUIRED PIPING METHOD #5** (see page 4).
6. Refer to page 3 of this bulletin for correct Setup Instructions.

Maximum Operating Pressure 125PSI (860 KPA) for Hot and Cold Water.

CAUTION

All thermostatic water-mixing valves have limitations. They will not provide the desired accuracy outside of their flow capacity range. Consult the capacity chart on page 12. Minimum flow must be no less than as shown.

1360 Elmwood Avenue, Cranston, RI 02910 USA

Phone: 401.461.1200 Fax: 401.941.5310

Email: info@leonardvalve.com

Web Site: <http://www.leonardvalve.com>

TM-2020B-2P ADJUSTMENT AND SERVICE ONLY

<p>Leonard Type TM Thermostatic Water Mixing Valves are simple in design and may be easily cleaned, adjusted and repaired. If the installation is accessible, servicing may be completed without disconnecting the valves.</p>	<p>NOTE: Parallel Systems include Thermostatic Water Mixing Valves, which must be regularly maintained to provide best performance. Frequency of cleaning depends on quality of local water conditions and usage. See Maintenance Guide and Record MGR-1000</p>
--	--

⚠ WARNING ⚠

These mixing valves are equipped with an adjustable high temperature limit stop factory set at approximately 120°F (49°C) with an incoming hot water supply temperature of 150°F (65.5°C). If the hot water supply temperature of the job is greater than 150°F (65.5°C), the valves when turned to full HOT will deliver water in excess of 120°F (49°C) and the limit stop **MUST BE RESET BY THE INSTALLER!**

TO RESET ADJUSTABLE HIGH TEMPERATURE LIMIT STOP:

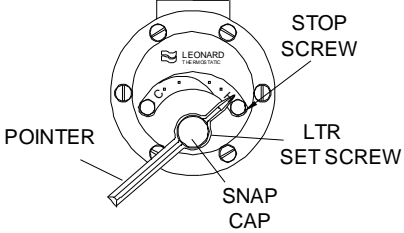
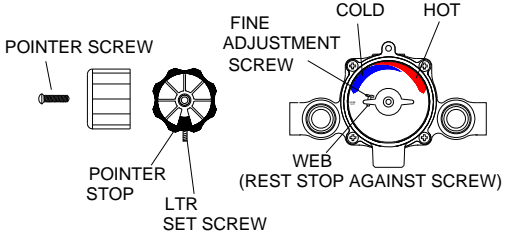
<p style="text-align: center;">TM-2020B LARGE MIXING VALVES</p>  <ol style="list-style-type: none"> 1. Loosen LTR screw 2. Remove SNAP CAP, SCREW & WASHER, Remove POINTER. 3. Temporarily place POINTER on the spline rod, turn RIGHT for warmer temperature, turn LEFT for cooler temperature. When valve is delivering warmest temperature desired, remove the pointer. 4. Replace POINTER on the spline rod so that its RIGHT edge is resting against the STOP SCREW located on the RIGHT SIDE OF THE COVER. 5. The new maximum temperature has now been set. Test this temperature by holding a thermometer under the flow of water to be certain it is as desired. <p>* LIMIT STOP MUST BE RESET AND RECHECKED EACH TIME HANDLE IS REMOVED.</p>	<p style="text-align: center;">TM-2020B SMALL MIXING VALVES</p>  <ol style="list-style-type: none"> 1. Loosen LTR Set Screw, remove POINTER SCREW. 2. Adjust POINTER to maximum desired temperature. 3. Remove POINTER, replace POINTER on spline rod with STOP (which is cast into the underside on the pointer), resting against the BOTTOM side of the WEB on the FINE ADJUSTMENT SCREW. 4. If fine adjustment is needed, adjust FINE ADJUSTMENT SCREW on the cover, loosen for hotter or tighten for cooler temperature. 5. Replace POINTER and check temperature, if set to desired temperature replace POINTER SCREW, and tighten LTR SET SCREW. 6. The new maximum temperature has now been set. Test this temperature by holding a thermometer under the flow of water to be certain it is as desired. <p>* LIMIT STOP MUST BE RESET AND RECHECKED EACH TIME HANDLE IS REMOVED.</p>
--	--

IMPORTANT! ALL MIXING VALVES MUST BE SET AT THE SAME OPERATING TEMPERATURE.

SEE PAGES: 6 & 7 FOR COMPLETE PARTS BREAKDOWN

Check for significant variations in outlet flow. Thermostatic valves will NOT provide the desired accuracy outside of their flow capacity range. Minimum flows must be no less than shown (see Flow Capacities, page 12).

If installed on a recirculated hot water system, make certain the valve is piped according to Leonard's Required Piping Methods (see page 4).

REMEMBER! THIS IS A CONTROL DEVICE WHICH MUST BE CLEANED AND MAINTAINED ON A REGULAR BASIS. (SEE MAINTENANCE GUIDE AND RECORD, MGR-1000).

SETUP INSTRUCTIONS

FOR BOTH 2020B-2P

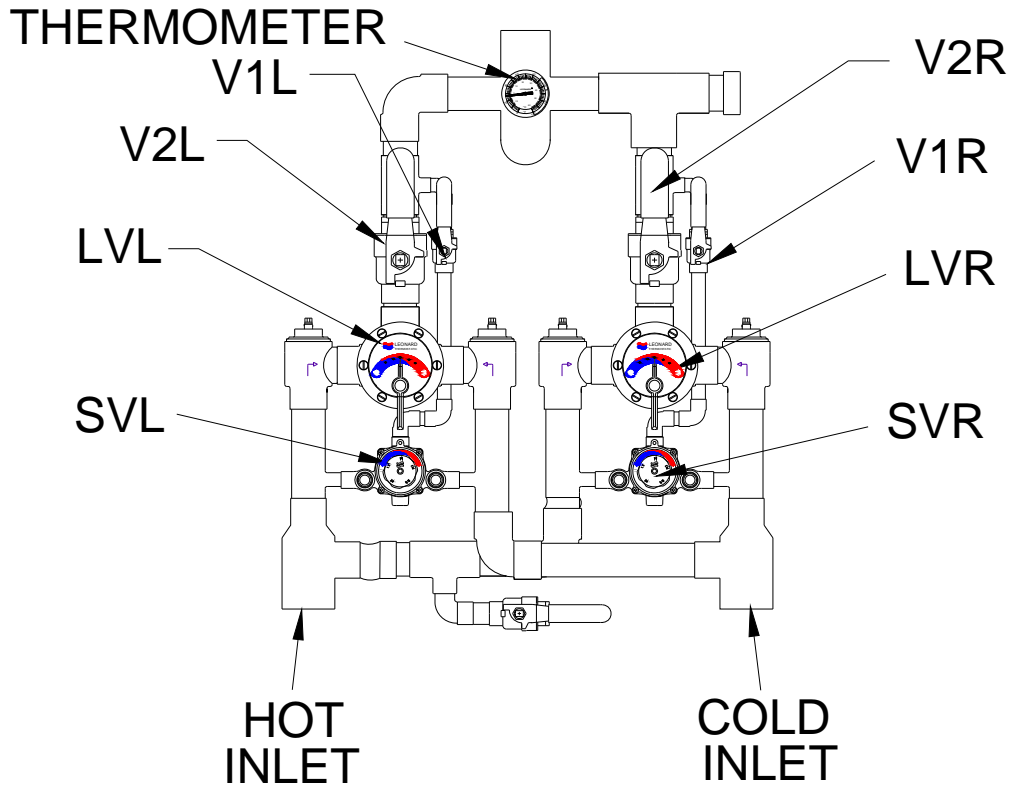

- | | |
|---|--|
| <ol style="list-style-type: none"> 1. The Parallel Unit MUST be piped according to a Leonard Required Piping Method 5 (see page 4). 2. Make sure full hot and cold supplies to this assembly are operating. The temperature of the hot water source must be properly set and maintained. 3. The circulator (if used) must be turned OFF before setup. 4. Turn on enough fixtures for a flow of at least <u>30 GPM</u> (114 l/min.) downstream from this system. Make sure each fixture is set to deliver full "HOT" water. 5. Close outlet ball valves V1R, V2R, V1L. 6. Make sure ball valve V2L is in the full open position. 7. Set outlet temperature of the mixing valve LVL to the required level. | <ol style="list-style-type: none"> 8. Open ball valve V2R and shut ball valve V2L at the mixing valve. 9. Set outlet temperature of the mixing valve LVR to the same temperature as step 7. 10. Turn off enough fixtures for a flow of at least 2 GPM (7.6 l/min) downstream from this system. Make sure each fixture is set to deliver full "HOT" water. 11. Open V1L, shut off ball valve V2R 12. Set outlet temperature of mixing valve SVL to the same temperature as Step 7. 13. Open V1R and shut V1L, set outlet temperature of SVR mixing valve to the same temperature as STEP 7. 14. Open all outlets. System is operational. To balance circulation system temperature, see page 5 . |
|---|--|

NOTE! FOR OPTIONAL OUTLET SETUP PIPING ARRANGEMENT, SEE PAGE 12

REQUIRED PIPING METHOD #5

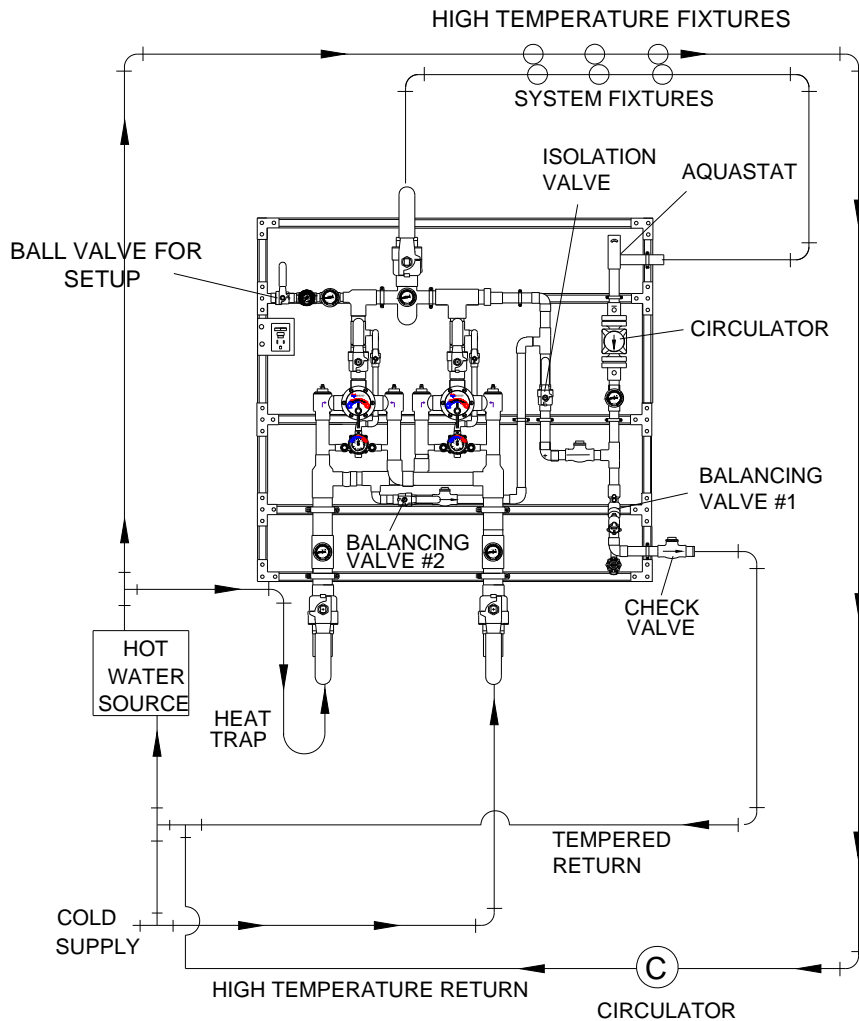

PROCEDURE TO BALANCE CIRCULATION SYSTEM

1. MAKE SURE NO WATER IS BEING DRAWN IN THE BUILDING. OPEN BALANCING VALVE #1 APPROXIMATELY HALF WAY AND START CIRCULATOR. KEEP BALANCE VALVE #2 CLOSED AT THIS TIME
2. OBSERVE TEMPERATURE UNTIL IT STABILIZES.
3. CLOSE BALANCING VALVE #1 SLIGHTLY IF TEMPERATURE IS TOO HOT, OR OPEN IT SLIGHTLY IF TEMPERATURE IS TOO COLD. ALLOW TEMPERATURE TO STABILIZE, REPEAT UNTIL DESIRED CIRCULATION TEMPERATURE IS SET.
4. IF UNABLE TO REACH DESIRED TEMPERATURE WITH VALVE #1 IN THE FULL OPEN POSITION, OPEN BALANCE VALVE #2 IN SMALL INCREMENTS (i.e. 1/8, 1/4, 3/8, ETC) UNTIL DESIRED TEMPERATURE IS ACHIEVED.

REMEMBER! THIS IS A CONTROL DEVICE WHICH MUST BE CLEANED AND MAINTAINED ON A REGULAR BASIS (SEE MAINTENANCE GUIDE AND RECORD, MGR-1000).

INSTRUCTIONS FOR SERVICING LARGER TM2020B VALVE

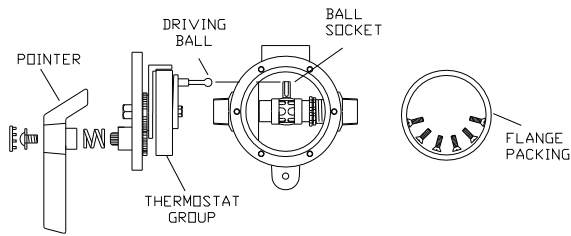

1. Loosen LTR set screw.
2. Remove snap cap, screw and washer, friction spring and pointer.
3. Turn off hot and cold supplies at checkstops. Remove TM-16 cover screws to release cover and thermostatic control assembly.
4. To clean port sleeve assembly, (the thimble must move freely on the port sleeve): unscrew the check nut as far as it will go, then screw the port sleeve nut into the base. The port sleeve and thimble may be lifted out. SEE DWG BELOW
5. Clean in a non-corrosive cleaning solution. **DO NOT USE ABRASIVES!** The port sleeve should be reassembled in the valve.

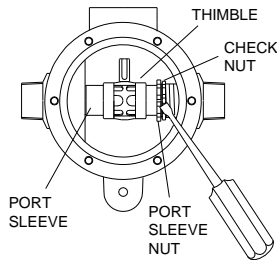

6. To clean thermostat group, remove coil sleeve stud and take off thermostat group.
7. Clean in a non-corrosive cleaning solution.
8. When reassembling, make sure driving ball of thermostat group engages the ball socket of the port sleeve assembly.

INSTRUCTIONS FOR SERVICING SMALLER TM2020B VALVE

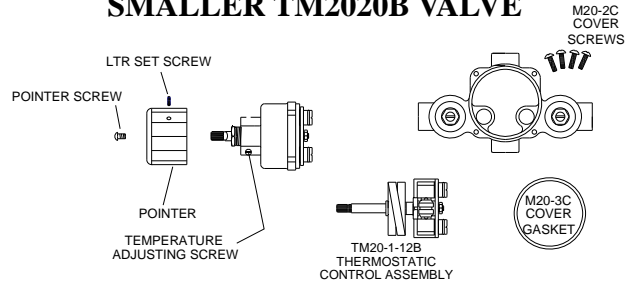

1. Loosen LTR set screw.
2. Remove pointer screw, and pointer.
3. Turn off hot and cold supplies at screwdriver checkstops. Remove M20-2C cover screws to release cover and thermostatic control assembly.
4. To remove bridge assembly, TM28-1-8B, remove pointer rod nut (MU-10B) and pull bridge assembly off control rod.
5. To clean submerge bridge assembly in clean water or non-corrosive cleaning solution. **DO NOT USE ABRASIVES!** Be certain thimble moves freely on port sleeve. Note! Driving ball on thimble must engage coil bracket in assembling.

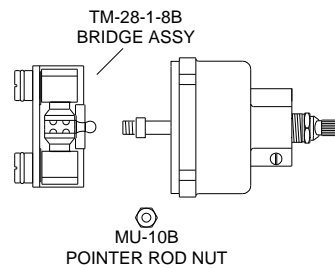

6. To disassemble bridge assembly, see drawing next page (remove TM25-3A holder nuts with screwdriver in slots provided).
7. To clean thermostat coil, remove retaining ring and stop, loosen gland nut. Push rod through cover. Be careful not to pull coil out of shape.

TROUBLESHOOTING INSTRUCTIONS

Note: Provide serial number when ordering parts for each valve!

		LARGE VALVE	SMALL VALVE
PACKING & GASKETS	<ol style="list-style-type: none"> 1. Leaks at stem. 2. Leak between valve cover and base. 	Repair Kit # 1/200Y	Repair Kit # 1/26 (Packings & Gaskets)
PORT SLEEVE/BRIDGE ASSEMBLY	<ol style="list-style-type: none"> 3. Valve delivers either all hot or all cold water, or will not mix consistently. 	Repair Kit # R/200N	Repair Kit #R/28 (Rebuilding Kit) or TM28-1-8B Bridge Assembly
THERMOSTAT GROUP	<ol style="list-style-type: none"> 4. After cleaning or replacing port sleeve/ bridge assembly, valve performance is not consistent. 	Repair Kit # R/200N	Repair Kit #R/28 (Rebuilding Kit) or TM-28-G2 Thermostat Group
CHECKSTOPS	<ol style="list-style-type: none"> 5. Hot water by-pass into cold line(or cold into hot). 6. Supplies cannot be shut off completely. Supplies leak at checkstop bonnets. 	Repair Kit #2/200Y	Repair Kit #4/M20 (Checkstop Kit)

TM-2020B LARGE VALVE PARTS

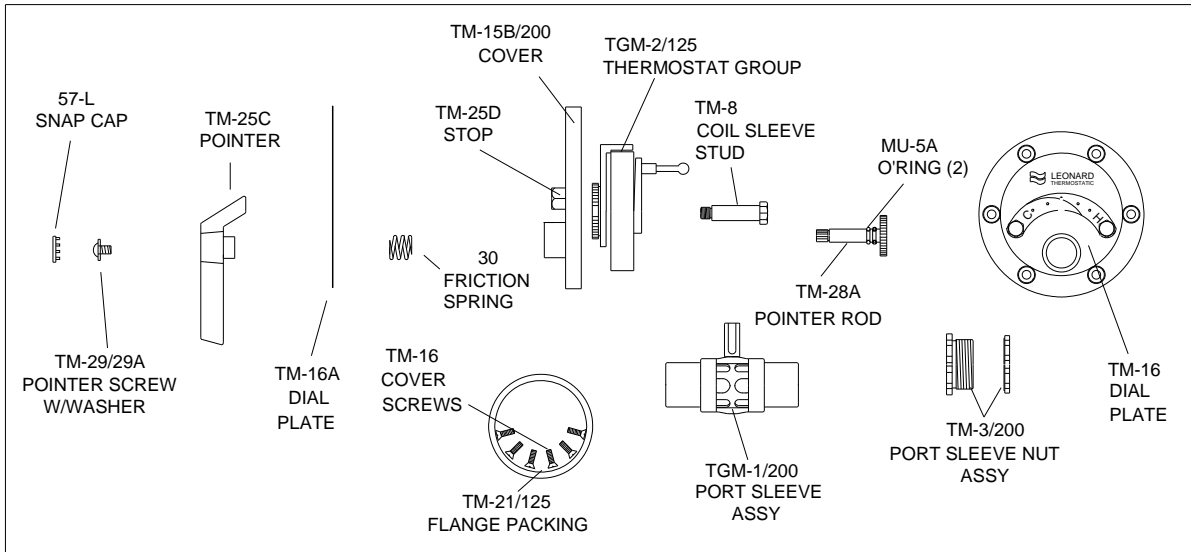

CHECKSTOP PARTS

REPAIR KITS

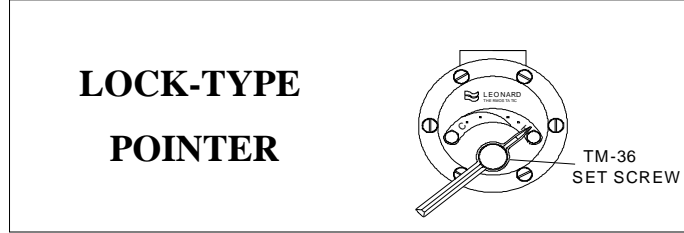
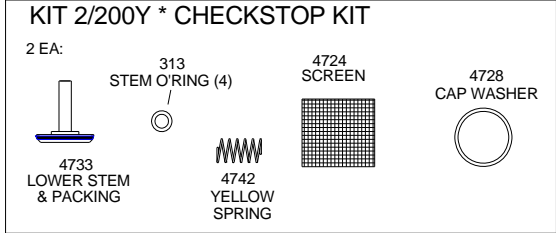
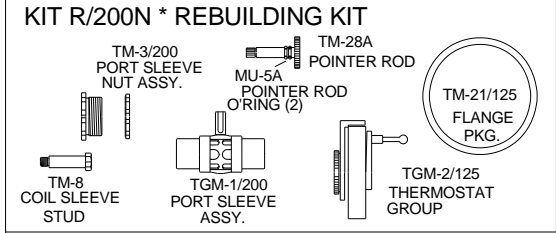
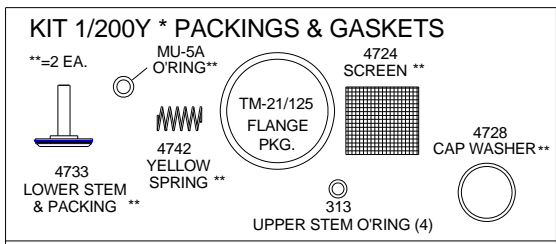
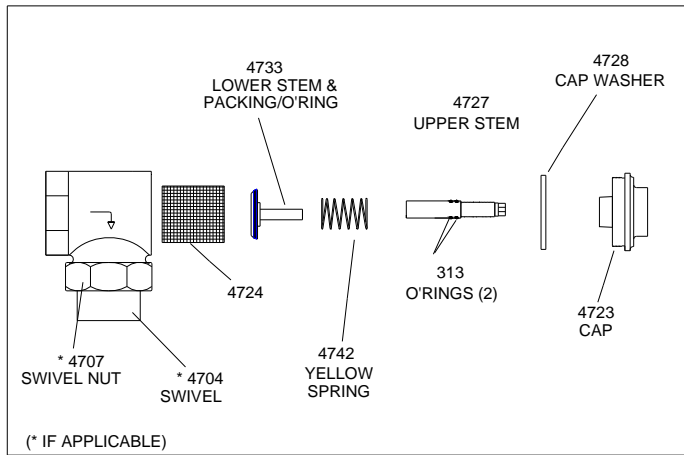

REMEMBER! THIS IS A CONTROL DEVICE WHICH MUST BE CLEANED AND MAINTAINED ON A REGULAR BASIS (SEE MAINTENANCE GUIDE AND RECORD)

NOTE: AFTER INSTALLING NEW PARTS IT WILL BE NECESSARY TO RESET THE ADJUSTABLE HIGH TEMPERATURE LIMIT STOP ON EACH VALVE (SEE PAGE 2).

SMALL TM VALVE PARTS

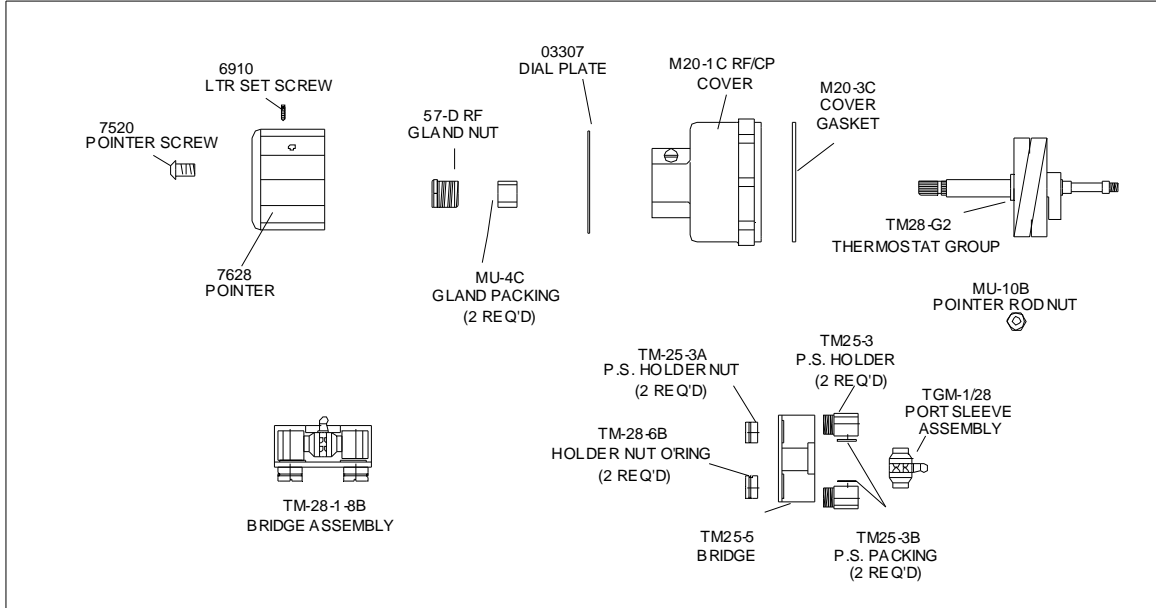

CHECKSTOP PARTS

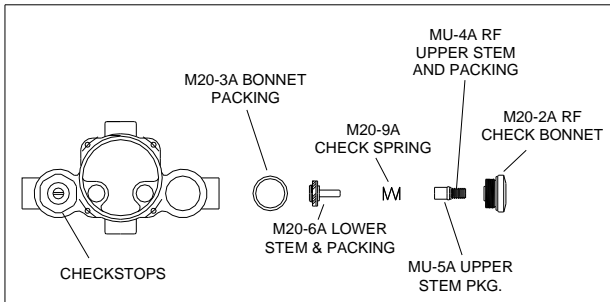

REPAIR KITS

KIT 1/26 PACKINGS & GASKETS

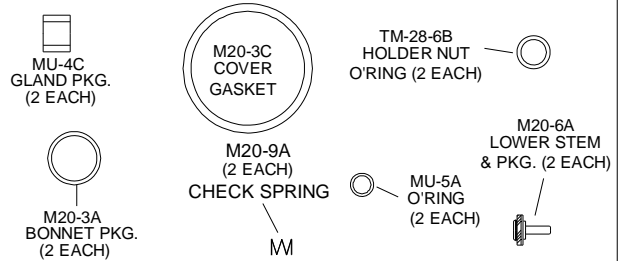

KIT R/28 REBUILDING KIT

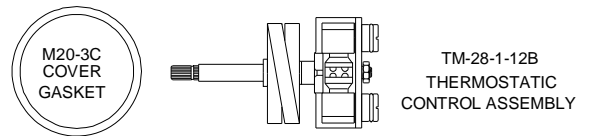

KIT 4/M20 CHECKSTOP KIT

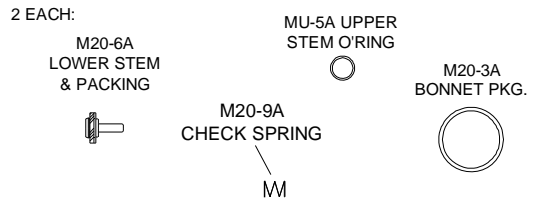

REMEMBER! THIS IS A CONTROL DEVICE WHICH MUST BE CLEANED AND MAINTAINED ON A REGULAR BASIS (SEE MAINTENANCE GUIDE AND RECORD)

NOTE: AFTER INSTALLING NEW PARTS IT WILL BE NECESSARY TO RESET THE ADJUSTABLE HIGH TEMPERATURE LIMIT STOP ON EACH VALVE (SEE PAGE 2).

**OPTIONAL OUTLET SETUP PIPING
(BY OTHERS)**

The addition of this piping arrangement (extra tee and ball valve) eliminates the need to turn fixtures on and off throughout the building at setup. The flows required in the setup instructions (page 3) are set by using Ball Valve A. (make sure main outlet ball valve is closed).

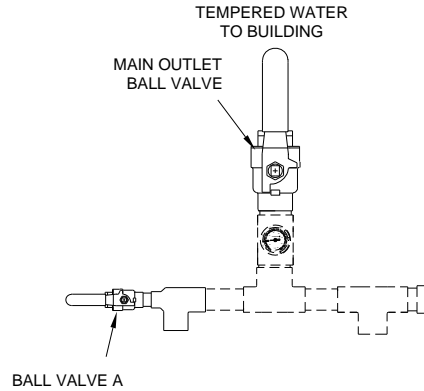

CAUTION! ALL THERMOSTATIC WATER MIXING VALVES AND SYSTEMS HAVE LIMITATIONS! THEY WILL NOT PROVIDE THE DESIRED PERFORMANCE OUTSIDE OF THEIR FLOW CAPACITY RANGE! CONSULT THE CAPACITY CHART BELOW AND OBSERVE MINIMUM FLOWS SHOWN.

FLOW CAPACITIES

DOUBLE FLOWRATE WHEN BOTH VALVES ARE OPERATING

SINGLE VALVE ASSEMBLY FLOWRATES SHOWN
(MINIMUM FLOW RATE HAS BEEN DOUBLED TO 2GPM)

TM-2020B-2P PARALLEL	MINIMUM FLOW (GPM)	SYSTEM PRESSURE DROP (PSIG)									
		5	10	15	20	25	30	35	40	45	50
	(l/min)	.3	.7	.97	1.4	1.7	2.1	2.4	2.8	3.1	3.4
2.0	78	113	129	145	163	172	188	197	214	226	GPM
8	295	428	488	549	617	651	712	746	810	856	l/min

LIMITED WARRANTY

Leonard Valve Company (hereinafter, "Leonard") warrants the original purchaser that products manufactured by Leonard will be free from defects in material or workmanship under normal conditions of use, when properly installed and maintained in accordance with Leonard's instructions, for a period of one year from the date of shipment. During this period, Leonard will at its option repair or replace any product, or part thereof, which shall be returned, freight prepaid, to the Leonard factory and determined by Leonard to be defective in materials or workmanship. Leonard provides no warranty, express or implied, which extends beyond the description contained herein. LEONARD SPECIFICALLY DISCLAIMS ANY AND ALL IMPLIED WARRANTIES OF MERCHANTABILITY OR OF FITNESS FOR A PARTICULAR PURPOSE. Nonetheless, some jurisdictions may not allow the disclaimer of certain implied warranties, in which case Leonard hereby limits such implied warranties to the duration of the limited warranty period contained herein. Some jurisdictions may not allow limitations on how long an implied warranty lasts, so the foregoing durational limitation may not apply to you. In no event will Leonard be liable for labor or incidental or consequential damages. Any alteration or improper installation or use of this product will void this limited warranty. If any provision of this limited warranty is prohibited by law in the applicable jurisdiction, such provision shall be null and void, but the remainder of this limited warranty shall continue in full force and effect.